



B BRICKSTYL

① LE CORNICI PER ESTERNO

ⒸB EXTERIOR MOULDINGS

Ⓔ MOLDURAS DECORATIVAS PARA EXTERIORES

ⒸD PERFIS PARA EXTERIOR

BOVELACCI



BAF9011, BF9011, BM9012,
BS9001, BS9002,

BOVELACCI



BRICKSTYL

-  LE CORNICI PER ESTERNO
-  EXTERIOR MOULDINGS
-  FASSADENPROFILE
-  CORNICHES POUR FACADES
-  MOLDURAS DECORATIVAS PARA EXTERIORES
-  PERFIS PARA EXTERIOR
-  GEVELPROFIELEN
-  ΚΟΡΝΙΖΕΣ ΕΞΩΤΕΡΙΚΟΥ ΧΩΡΟΥ
-  DIŞ KARTONPIYER
-  UTVÄNDIGA LISTER
-  UTVENDIGE LISTER
-  FACADELISTER
-  ULKOKÄYTTÖÖN TARKOITETUT LISTAT
-  DECORATIVNI FASADNI PROFILI
-  FASADNI PROFILI
-  ФАСАДНЫЕ ПРОФИЛИ
-  GZYMSY ZEWNĘTRZNE
-  LIŠTY PRO ÚPRAVU FASÁDY
-  CORNISE PENTRU EXTERIOR
-  HOMLOKZATPROFIL
-  ФАСАДНІ ПРОФІЛІ
-  ФАСАДНИ ПРОФИЛИ
-  外部裝飾
-  室外用飾り縁

POLISTIRENE RIVESTITO
COATED POLYSTYRENE

BOVELACCI

①

LE CORNICI PER PORTE E FINESTRE

Cornici per esterno in polistirene rivestito
Non portanti
Lunghezza: 2 ml per asta

Ⓒ

DOOR AND WINDOW FRAMES

Facade profiles, coated polystyrene
Not supporting
Length: 2 lm (78 3/4")

Ⓔ

MOLDURAS PARA PUERTAS Y VENTANAS

Molduras para exteriores en poliestireno extruido revestido
No soportan peso
Longitud: 2 metros

⒫

PERFIS PARA PORTAS E JANELAS

Perfis para exterior em poliestireno extrudido e revestido
Não portante
Comprimento: 2 ml por barra

BM9014

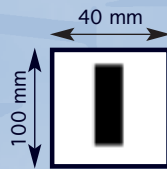

40 mm

100 mm

3 7/8" x 1 5/8"

BM9021

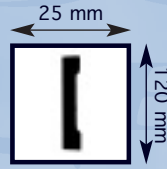

25 mm

120 mm

4 3/4" x 1"

BM9022

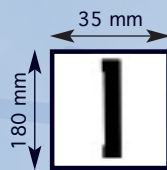

35 mm

181 mm

7" x 1 3/8"

BM9020

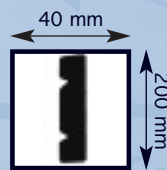

40 mm

200 mm

7 7/8" x 1 5/8"

BF9023

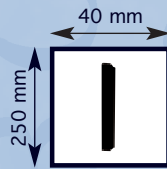

40 mm

250 mm

9 7/8" x 1 5/8"

BM9025

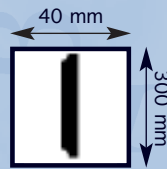

40 mm

300 mm

11 3/4" x 1 5/8"

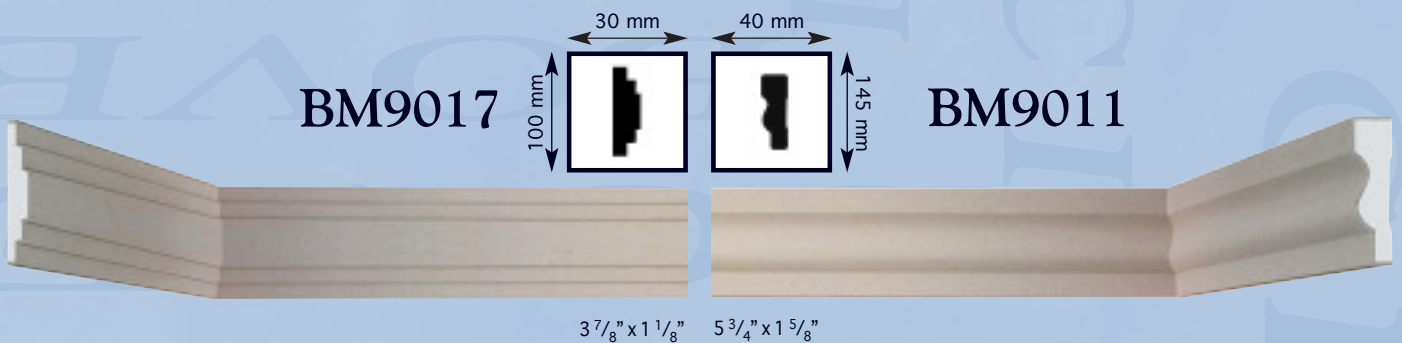
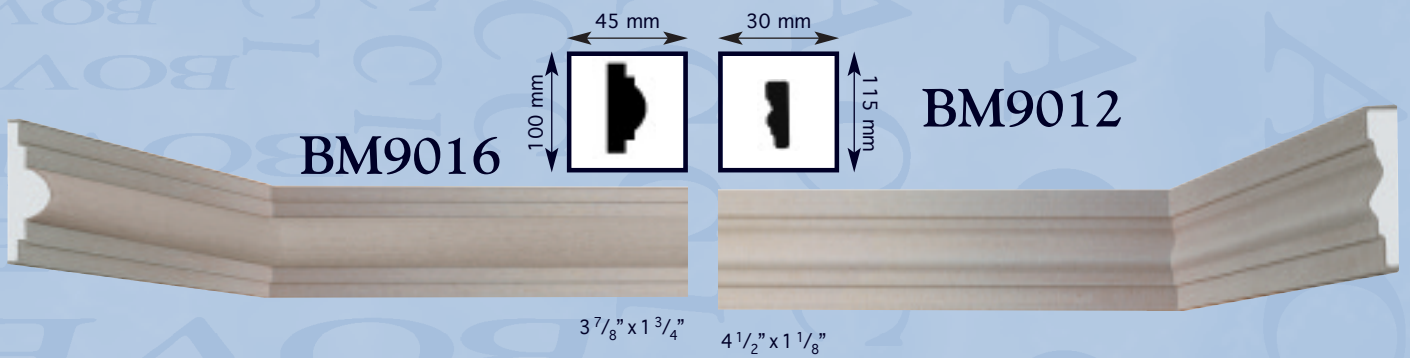
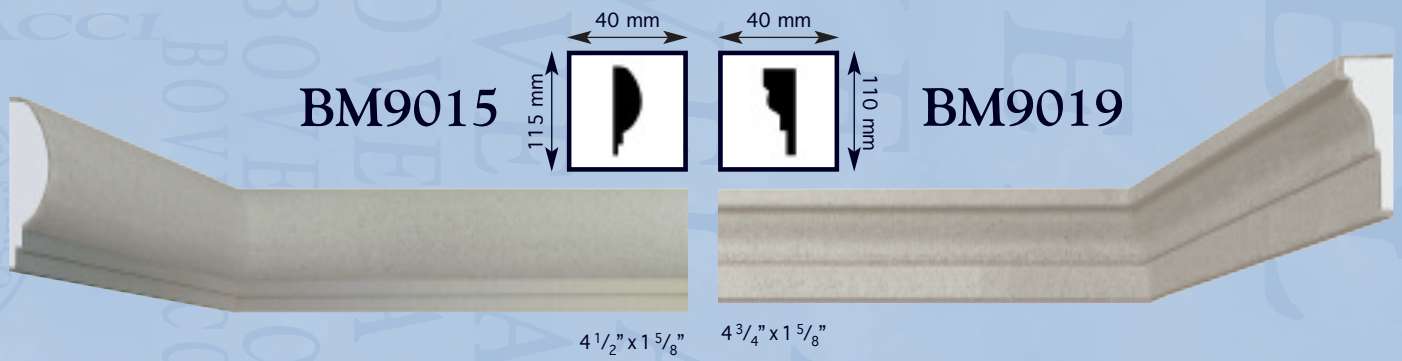
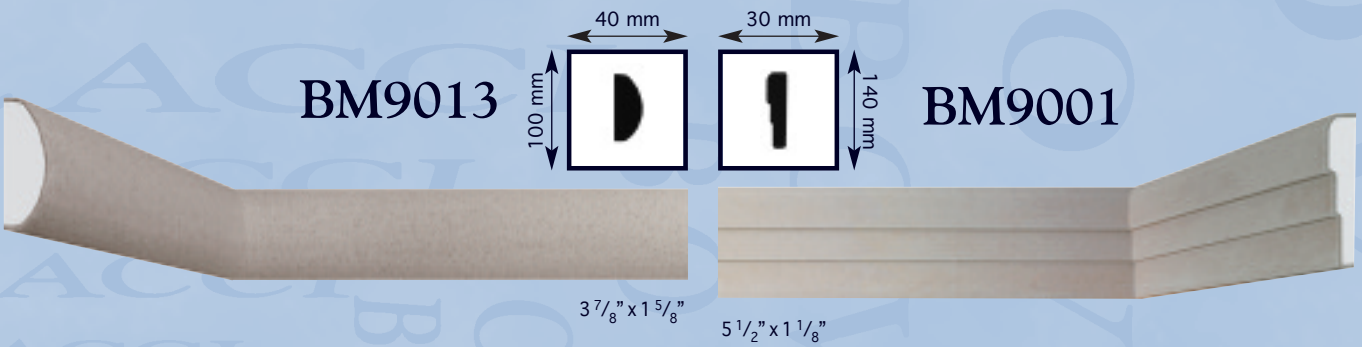
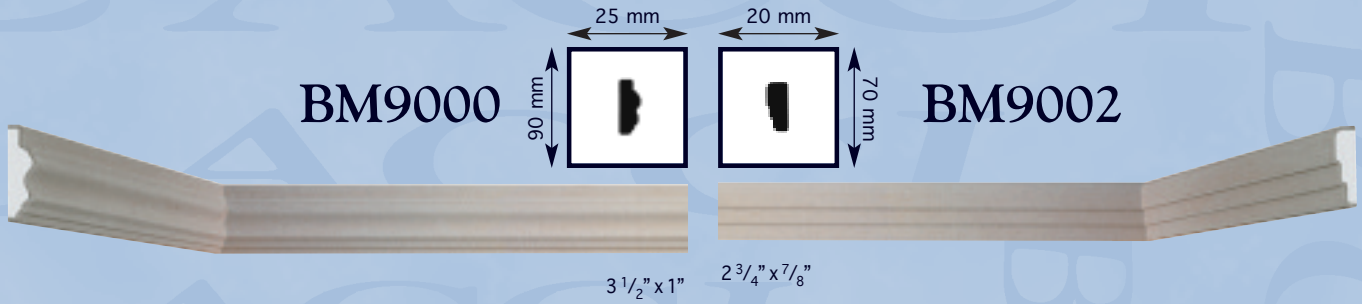

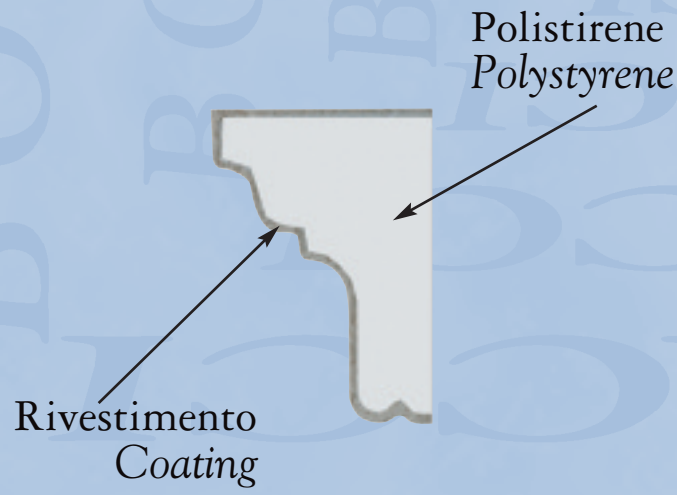
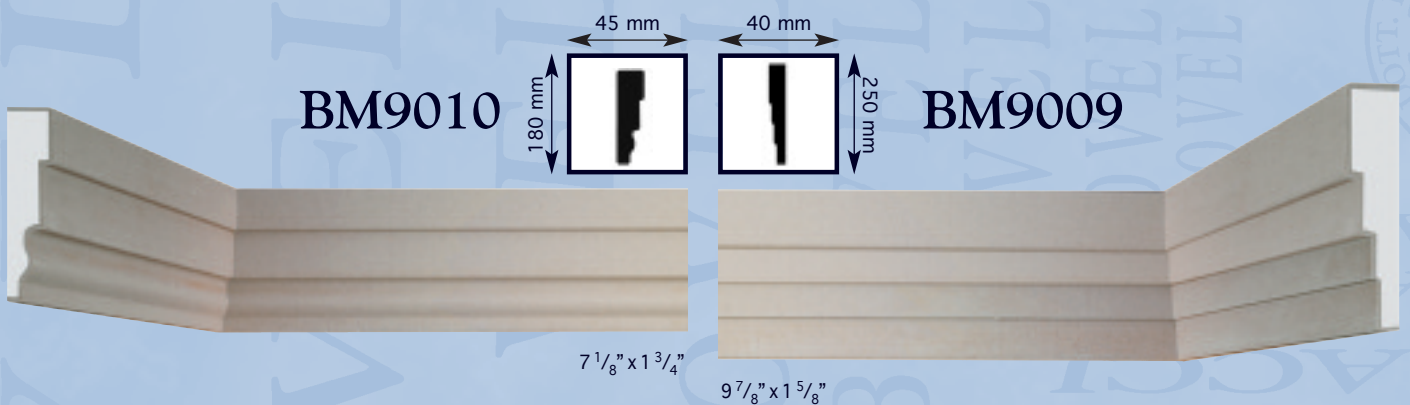
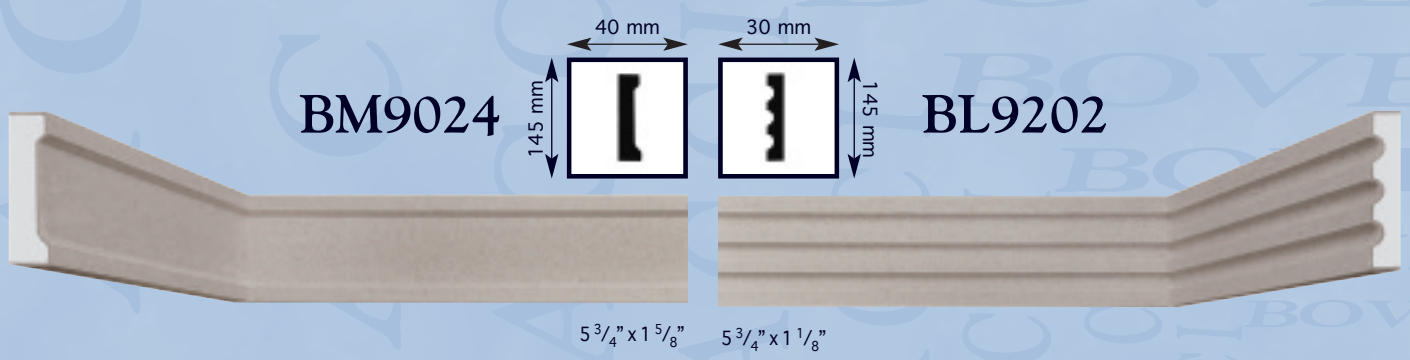
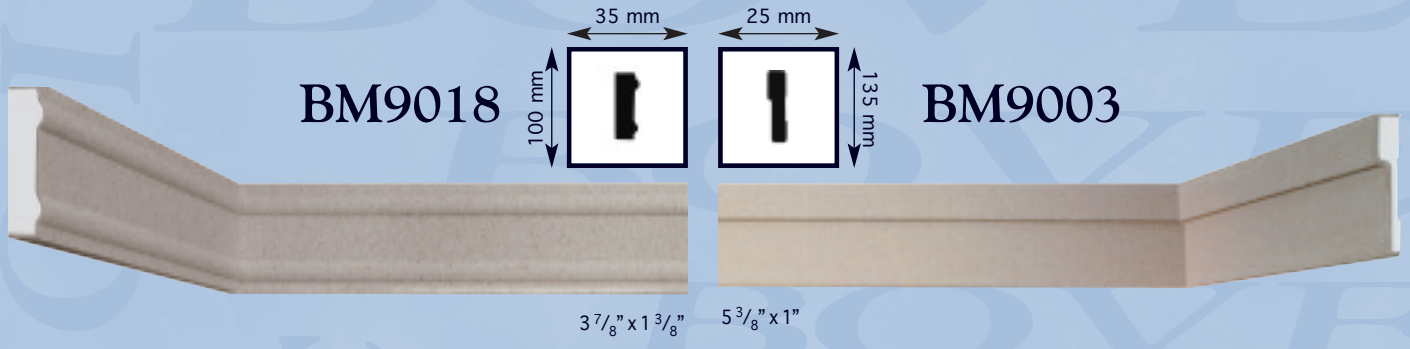

① LE CORNICI PER DAVANZALI ② WINDOW-SILLS ③ MOLDURAS PARA ANTEPECHOS ④ PARAPEITOS

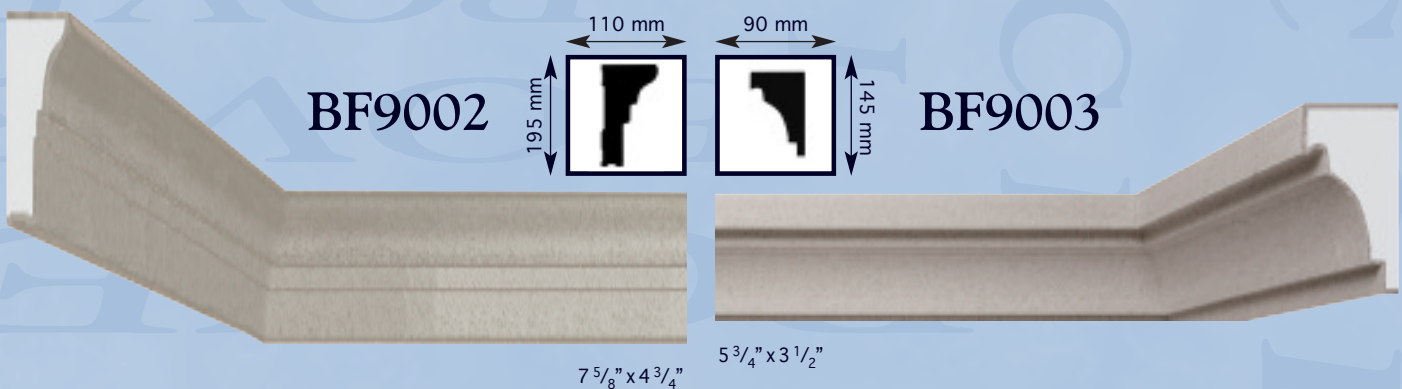
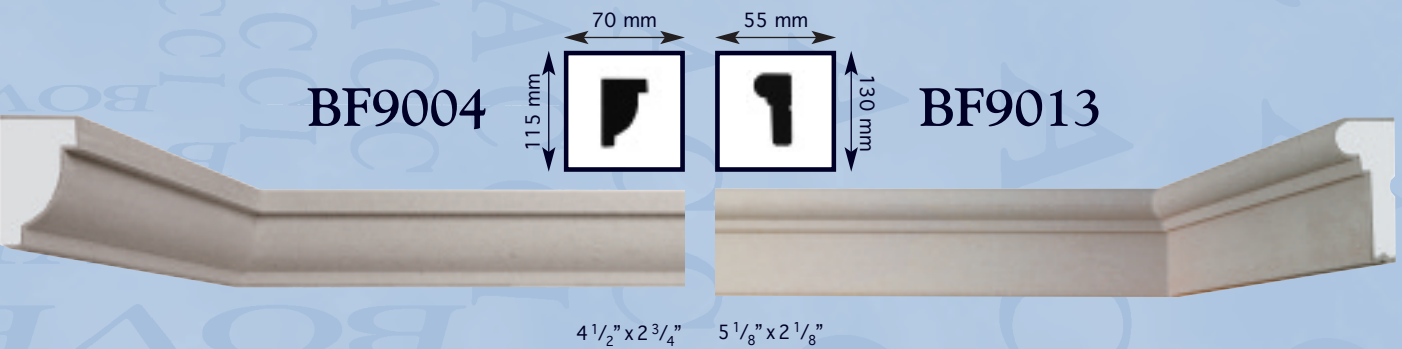
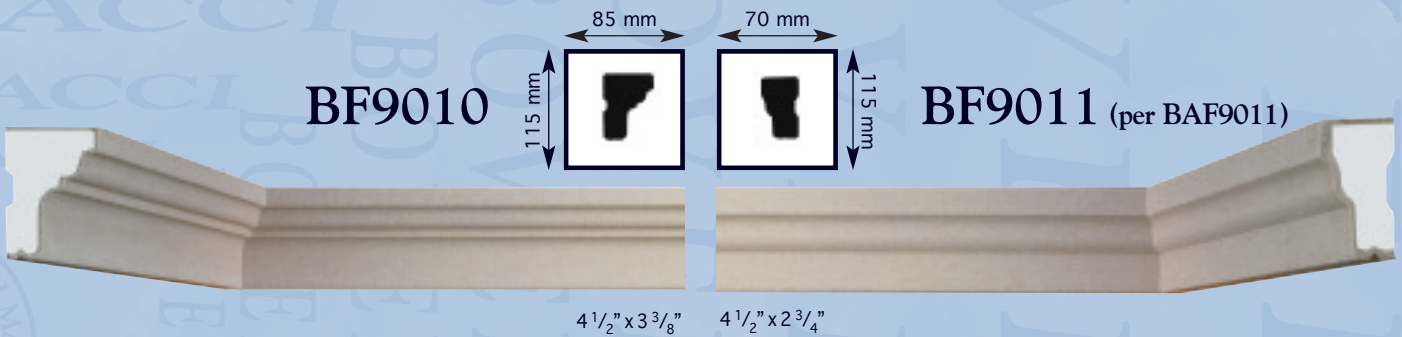
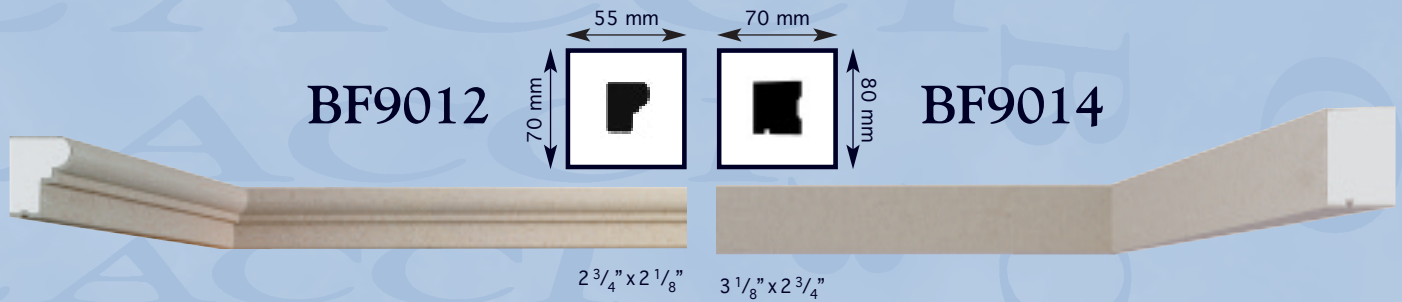



BF9001



BF9095

7 1/2" x 3 1/2"

Ⓘ LA CORNICE PER
CORNICIONI

ⒼⒷ CORNICE
MOULDING

Ⓔ MOLDURAS PARA
CORNISAS

⒫ QUADRO PARA
CORNICE



BG9020*



BG9030*

7 1/2" x 3 1/2"

*in eps

*in expanded PS

*en poliestireno expandido

*em poliestireno expandido

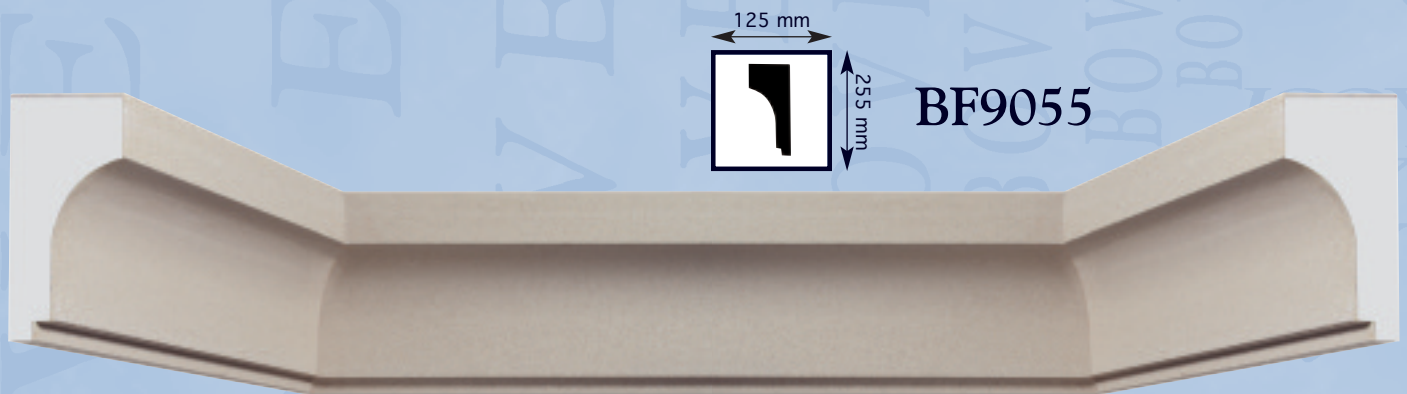

BF9055

10" x 4 7/8"

I FRONTONI

HEADERS

MARQUESINAS

FRONTÕES

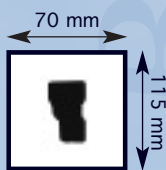

4 1/2" x 2 3/4"

BAF9011 (per BF9011)

interno 90 cm

internal 35 3/8"



①

LA PANNELLATURA
PER RIVESTIMENTI

②

PANELS

③

TABLAS

④

TÁBUAS

BP9027

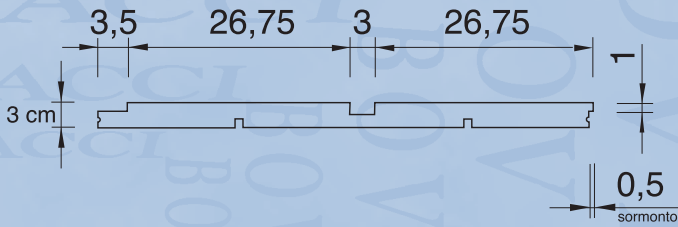
H. 60 cm (dimensione utile 59,5 cm) x p. 3 cm
H. 23 ⁵/₈" (23 ³/₈) x d. 1 ¹/₈

Esempi di realizzazione:

Examples of realization:

Ejemplos de empleo:

Algumas realizações

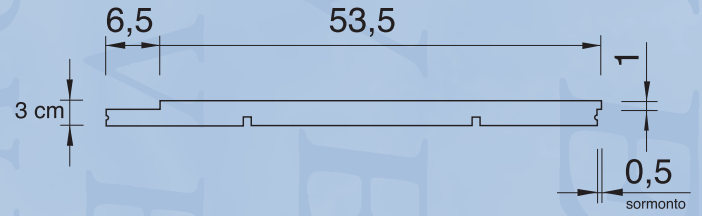

BP9054

H. 60 cm (dimensione utile 59,5 cm) x p. 3 cm
H. 23 ⁵/₈" (23 ³/₈) x d. 1 ¹/₈

IL DISPLAY BRICKSTYL

BOVELACCI

① L'ANGOLARE PER RIVESTIMENTI

② CORNER PROFILE

③ ÁNGULAR

④ ÂNGULO

BP9004

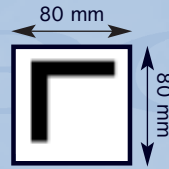
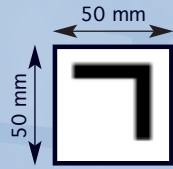

BP9006

2" x 2" (int. 1 5/8" x 1 5/8")

3 1/8" x 3 1/8" (int. 2 3/8" x 2 3/8")

BP9008

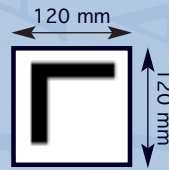
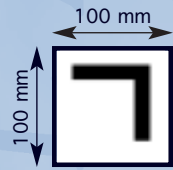

BP9010

3 7/8" x 3 7/8" (int. 3 1/8" x 3 1/8")

4 3/8" x 4 3/8" (int. 3 7/8" x 3 7/8")

BP9012*

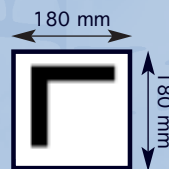
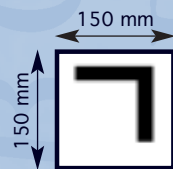

BP9015*

5 7/8" x 5 7/8" (int. 4 3/4" x 4 3/4")

7 1/8" x 7 1/8" (int. 5 7/8" x 5 7/8")

①

LE MENSOLE

**BC9001**

L.19 x p.15 x H.30 cm
 (L.7 1/2" x d.5 7/8" x H.11 3/4")

Ⓒ

CONSOLES

**BC9002**

L.19 x p.16,5 x H.29,5 cm
 (L.7 5/8" x d.6 3/4" x H.11 5/8")

Ⓔ

MENSULAS

Ⓟ

CONSOLAS

**BC9005**

L.19 x p.20 x H.25 cm
 (L.7 5/8" x d.7 7/8" x H.9 7/8")

LE BUGNE

STONES

PIEDRAS

PEDRAS

**BB9011**

25 x 25 x p.4 cm
 (9 7/8" x 9 7/8" x d.1 5/8")

**BB9010**

37,5 x 25 x p.4 cm
 (14 1/2" x 9 7/8" x d.1 5/8")

**BB9021**

30 x 30 x p.4 cm
 (11 3/4" x 11 3/4" x d.1 5/8")

**BB9022**

40 x 30 x p.4 cm
 (15 3/4" x 11 3/4" x d.1 5/8")

**BB9020**

50 x 30 x p.4 cm
 (19 5/8" x 11 3/4" x d.1 5/8")

LE CHIAVI

KEYSTONES

CLAVES DE ARCO

PEDRAS DE CHAVE



BS9001
20 x 15 x p.7,5 cm
(7⁷/₈" x 5⁷/₈" x d.3")



BS9002
20 x 17 x p.10 cm
(7⁷/₈" x 6³/₄" x d.3⁷/₈"



BS9010
20 x 20 x p.7 cm
(7⁷/₈" x 7⁷/₈" x d.2³/₄"



BS9011
14,5 x 14,5 x p.6,5 cm
(5³/₄" x 5³/₄" x d.2³/₄"



BS9012
11,5 x 11,5 x p.4,5 cm
(4¹/₂" x 4¹/₂" x d.")



BS9013
10 x 10 x p.3 cm
(3⁷/₈" x 3⁷/₈" x d.1¹/₈"



BS9014
8 x 8 x p.3 cm
(3¹/₈" x 3¹/₈" x d.1¹/₈"

①

LA LESENANon portanti;
componibili

®

PILASTERNot supporting;
modular

®

PILARNo soportan peso;
armable

®

LESENANão portante;
Intermutável

BL9201

BL9202

BL9201



BL9201

L.21 x p.7 x H.15 cm
(L. 8 1/4" x d. 2 3/4" x H. 5 7/8")

BL9202

L.200 x 14,5 x p.3 cm
(L. 78 3/4" x d. 5 3/4" x H. 1 1/8")

Esempio di realizzazione:

Example of realization:

Ejemplo de empleo:

Alguma realizaçvões

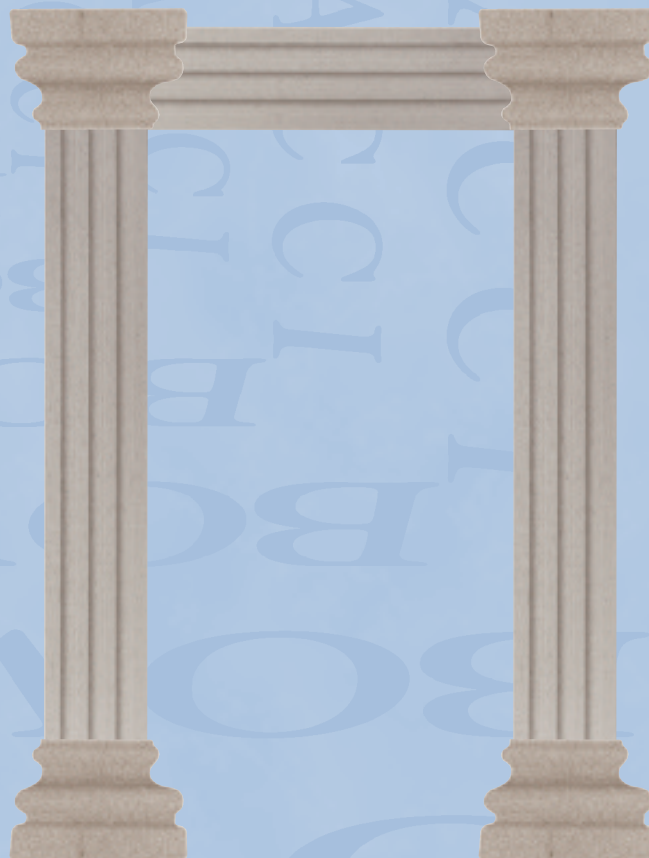
**BOVELACCI**

(I)

LE ISTRUZIONI PER IL MONTAGGIO

Assicurarsi che il muro sia pulito e senza tracce di grassi. Verificare la tenuta della pittura ed eventualmente applicare uno strato di fissativo.

Tagliare le cornici in modo da realizzare gli angoli che vi servono, verificando che combinino.

Applicare una colla speciale acrilica a base cementizia per rivestimenti esterni lungo le superfici posteriori dell'asta e sulle giunture. Mediante una leggera pressione applicare la cornice alla parete. Utilizzare anche tappi ad espansione. Lasciare asciugare.

Dopo una settimana riempire ogni giuntura o spazio con Bovelacci tipo BST2 (incidenza media stucco per le cornici: 1kg. X 20 ml).

Rimuovere quindi lo stucco in eccesso con una spugna bagnata. Lasciare asciugare e rifinire con una buona pittura elastica a base d'acqua od acrilica per esterno.

(GB)

ASSEMBLING INSTRUCTIONS

Examine your ceiling to be sure that it is clean and free of any grease. Verify the painted surface and if necessary apply a primer.

Cut straight ends to make the type of corners you need, checking that they match.

Apply a special acrylic and cement-based glue for external covering on the hind surfaces of the staff and on the joints. Press the moulding to the wall with a light pressure. Use also expanding stoppers. Let it dry. After a week fill all the joints or gaps with BST2 Bovelacci stucco (average incidence of stucco for mouldings: 1kg x 20 lm). Remove the stucco in excess by using a damp sponge. Let it dry and finish off with a good elastic water-based or acrylic paint for exterior.

(E)

INSTRUCCIONES DE MONTAJE

Los productos tienen que ser instalados en una superficie seca y limpia.

Cortar la moldura para obtener el ángulo que necesita. Confirme que calce.

Aplicar un pegamento acrílicos a base de cemento para revestimientos en las caras de la tira que se pegaran a la pared y entre las juntas.

Presionar levemente la moldura a la pared. Después de una semana llenar cada junta y espacio de estuco Bovelacci BST2 (promedio de consumo: 1 kg. x 20 ml).

Quitar el exceso de estuco con una espátula.

Limpiar usando una esponja.

Dejar que se seque y poner una buena elástica pintura a base de agua para exterior.

(P)

INSTRUÇÕES DE MONTAGEM

Os produtos devem ser aplicados sob paredes secas, limpas e desengorduradas.

Verificar o comportamento da pintura e eventualmente aplicar de primar.

Comece por cortar as sancas de modo a fazer os ângulos necessários. Preste atenção para ver se estão correctos.

Aplique uma cola acrílica para exterior em ambas as superfícies posteriores que serão colocadas em contacto com a parede e também nas as juntas.

Aplicar a sanca na parede com uma leve pressão.

Usar também pregos expansivos

Depois de uma semana preencher com a massa de enchimento Bovelacci BST2 (rendimento: 1 kg/20 m) todos os espaços entre as juntas.

Retirar o excesso de massa de enchimento com a ajuda de uma espátula.

Então limpar, com a ajuda de uma esponja.

Deixe secar e pinte com uma boa elástica tinta à base de água para exterior.

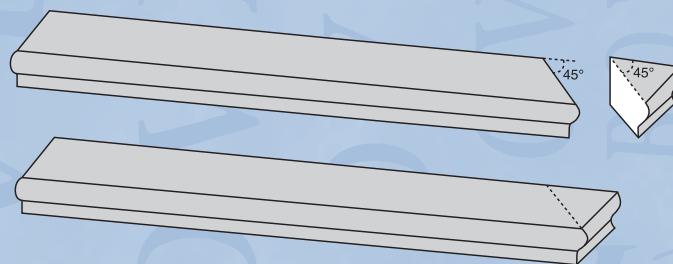

BST2 STUCCO

Kg 2

Lo stucco BST2 è da utilizzare solo per la stuccatura delle giunte e non per l'incollaggio.

Incidenza media: 1 kg x 20 ml

Per l'incollaggio si consigliano colle acriliche a base cementizia per rivestimenti esterni e l'utilizzo dei tappi ad espansione

BST2 STUCCO: use only as a filler, not as an adhesive.

Average incidence: 1 kgs x 20 m

As adhesive, we suggest acrylic glues for outside use and expanding nails

BST2 STUCCO: se debe usar solamente para estucar las juntas y no para pegarlas.

Promedio de consumo: 1 kg x 20ml. Para pegar se aconsejan pegamentos acrílicos a base de cemento para revestimientos de

BST2 STUCCO: usar somente como massa de enchimento. Não como cola.

Rendimento: 1 kg/20 m

Para colar recomendase a utilização de cola acrílica e pregos expansivos



WALL BRICKS ROSSO

215 x 50 x 5,8 mm

(8 ⁷/₁₆" x 1 ¹⁵/₁₆" x ⁴/₁₆")



1 - stendere la superficie da rivestire la malta BRICKCOLL con una spatola dentata.

1 - Lay down Brickcoll on the chosen surface with a spatula



2 - applicare le mattonelle , partendo da un lato, mantenendo una fuga tra le file di circa 1 cm

2 - Apply the single bricks, starting from one side, keeping a 1 cm distance between the edges



3 - ritoccare le fughe con un pennello bagnato per ottenere un effetto più realistico.

3 - Pass a wet brush on the open spaces to get a more realistic effect



4 - in prossimità dei bordi, le mattonelle possono essere sagomate con un semplice cutter.

4 - Bricks may be cut to size in order to fit the surface edges with a simple cutter



5 - in prossimità di angoli e curve, scaldare le mattonelle con aria calda o simili (es. un asciugacapelli) per dar loro la forma desiderata.

5 - Heat up the bricks with warm air (i.e. Hair drier) to make them fit the surface next to corners and curves

BRICKCOLL



Conf. Kg 8
(resa: 2,5 kg x 1mq)
(incidenza: 2,5 kg x 1 sm)



WALLBRICK



WALL BRICKS



WALL BRICKS



WALL BRICKS



WALL BRICKS



WALL BRICKS



WALL BRICKS



MUUR STEEN



ΕΠΕΝΑΥΣΗ ΤΟΙΧΟΥ ΜΕ ΟΥΨΗ ΤΟΥΒΛΟΥ



DUVAR TUGLASI



WALL BRICKS



WALL BRICKS



WALL BRICKS



TEKOTIILET



WALL BRICKS



WALL BRICKS



ИМИТАЦИЯ КИРПИЧА



IMITACJA CEGLY



CIHLOVÉ OBLOŽENÍ



IMITATIE DE CARAMIZI



IMITÁLT TÉGLA LOPOK



ІМІТАЦІЯ ЦЕГЛИ



ТУХЛИ ЗА СТЕНА



仿培砖



WALL BRICKS

IL RIVESTIMENTO IN FINTO MATTONO

Classe B1-DIN 4102 - sabbia silicea

FALSE WALL BRICK COVERING

Class B1-DIN 4102 - silicious sand



B BRICKSTYL



T TILESTYL **S** STARSTYL

I PANNELLI PER SOFFITTI
ED I CONTROSOFFITTI

TILES FOR CEILINGS
AND FALSE CEILINGS

I ITALSTYL **E** EUROSTYL **X** EXTRASTYL

C CLASSICSTYL **A** AMERICANSTYL

LE CORNICI, I ROSONI, LE TRAVI,
GLI ANGOLI ED I FREGI

IN POLISTIRENE ESTRUSO, ESPANSO, POLIMERI ESPANSI,
POLIURETANO E "POLISTRUTTURATO"

MOULDINGS, CEILING CENTRES, BEAMS,
CORNER BLOCKS AND DECORS

EXTRUDED AND EXPANDED PS, EXPANDED POLYMERS,
POLYURETHANE AND "POLISTRUTTURATO"



N NEWSTYL

I PROFILI IN POLIMERI ESTRUSI
AD ALTA DENSITÀ

HIGH DENSITY EXTRUDED
POLYMERS PROFILES



P PROFILSTYL

I PROFILI PER LA CASA
TRIMMINGS



B BRICKSTYL

PROFILI PER L'ESTERNO
EXTERIOR MOULDINGS



O OBJECTSTYL

LOGGETTISTICA
PATCHWORK OBJECTS



I MANICHINI
MANNEQUINS

E EUROSTYL

LE COLONNE
COLUMNS

W WOODSTYL

LE TRAVI IN POLIURETANO
POLYURETHANE BEAMS

K KRISTALSTYL

OGGETTI TRASPARENTI
TRANSPARENT OBJECTS



per carico merci:
Bovelacci Cargo - Via Fiume Ronco, 2
I-47122 Forlì - ITALY

Via del Commercio, 5
I-47122 Forlì - ITALY
Tel. +39 0543 811611
Fax +39 0543 721127



Le caratteristiche tecniche indicate nel presente catalogo vengono fornite a titolo indicativo e potranno essere modificate senza preavviso. Non devono quindi essere considerate a scopo di specificità. The given values are indicative and can be changed without notice. They cannot be considered like a state. This leaflet and the designs embodied within are protected by copyright law and international treaties. Unauthorized reproduction of the leaflet or any portion of it or reproduction of any of the designs embodied therein may result in severe civil penalties and will be prosecuted to the maximum. All right reserved, Bovelacci Forlì Italy.